



Network Dimmer Pack

Instruction Manual

Models:

NDP1210, NDP1213, NDP1216

NDPN1210, NDPN1213, NDPN1216

version 3.0 since 3 February 2020

ATTENTION!

This instruction manual contains important information about the installation and the use of the equipment. Please read and follow these instructions carefully.

Always ensure that the power to the equipment is disconnected before opening the equipment or commencing any maintenance work.

1. General information

IMPORTANT INSTRUCTIONS!

All safety and operating instructions should be read before the equipment is installed or operated.

IMPORTANT SAFETY INFORMATION

The following general safety precautions have to be observed during all phases of operation, service, and the repair of this equipment. Failure to comply with these precautions or with specific warnings in this manual violates safety standards of design, manufacture, and the intended use of this equipment.

Do not operate in an explosive atmosphere!

Do not operate this equipment in the presence of flammable gases or fumes. Operation of any electrical instrument in such an environment constitutes a definite safety hazard.

Water, moisture, heat and humidity

Do not operate this equipment near water or in areas with wet floors, or in high humidity atmosphere, where condensation forms on the equipment. It should never be placed near or over a heat register or other source of heated air. It should not be installed or operated without proper ventilation.

Power connections

This equipment must be earthed.

Let the equipment adapt the environment for at least 10 minutes after unpacking.

Please double check the signals of the power cable. Cable must be 5-wire (3L+N+E) with the CEE form input socket 32A/63A – 5-pin or hardwired to the installation rack.

Output connection

The output terminals are located inside the dimmer. Live, neutral and earth connections must be made to all load equipment.

DMX Input connection

DMX512 standard 3-pin and 5-pin XLR connectors are located on the rear panel of NDP12xx. DMX inputs are optically isolated.

Ethernet Art-Net, s.NET Input connection

Ethernet standard RJ45 input connector is located on the rear panel next to the DMX input connectors.

USB connector

There is a USB-A connector located on the front panel of the unit.

2. Functions and Control

Front panel:

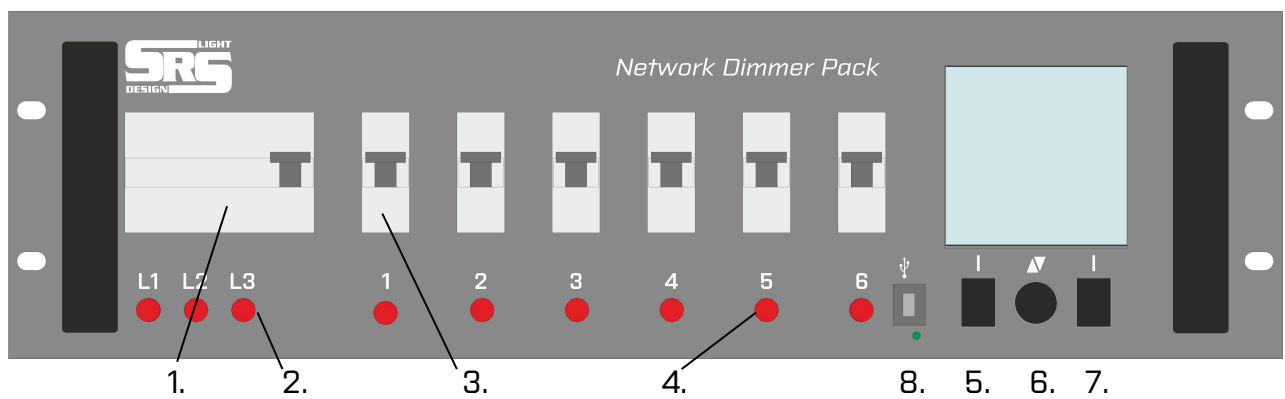
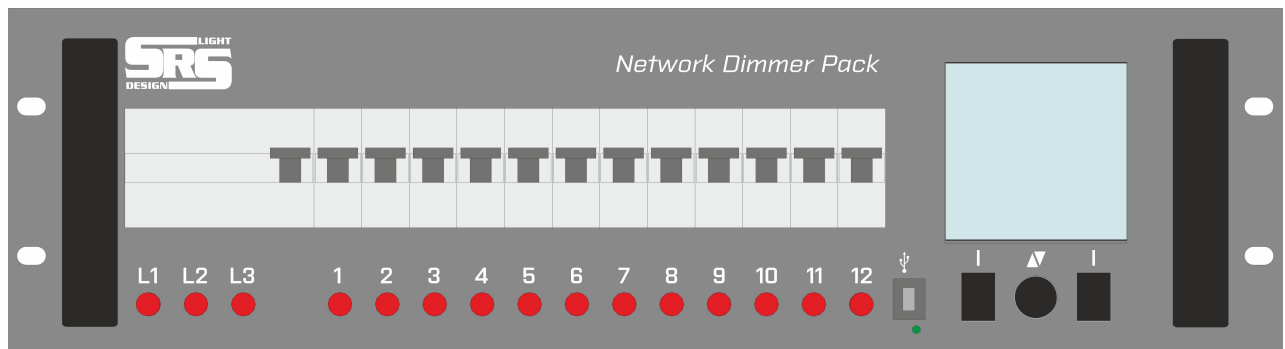

1. Residual current device
 - a. GF163 or 80A type A 30mA
 - b. Main switch on models marked as NDPxxxxB or NDPNxxxxB
2. Indicator of main input
3. Circuit breakers
 - a. **1P** for NDPxxxx
 - b. **1P+N** for NDPNxxxx
4. Output load indication /off when the lamp connection and channel level are set to zero/
5. Left selection key
6. Encoder
7. Right selection key
8. USB port

Rear panel:

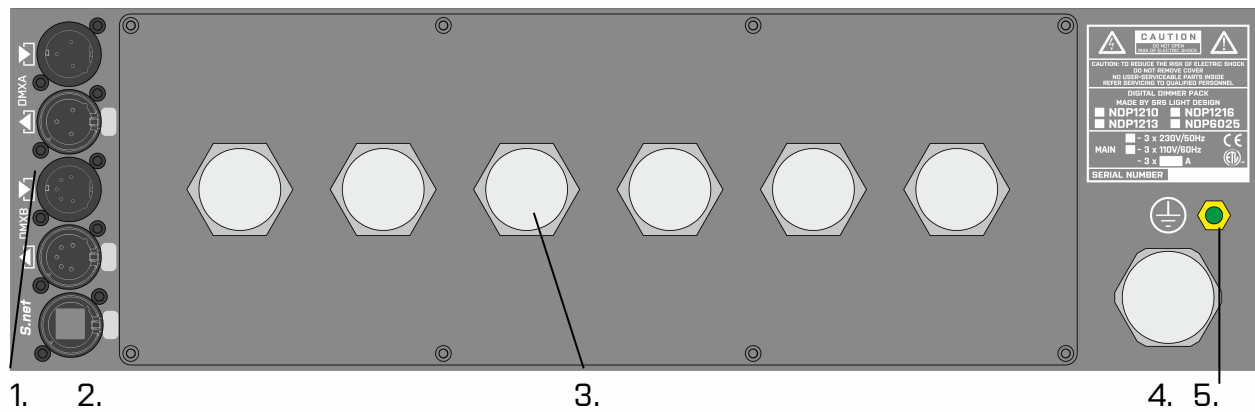

1. 2x DMX input/output
2. Ethernet
3. Dimmer output terminal
4. Power cable 5G6 or 5G10 according to the amperage of dimmer, 1.5m long
5. PE grounding point

2. Navigating menu

The navigation of NDP12xx is done using two buttons and the Encoder. Initial menu indicates the user defined name of unit, working mode, DMX start addresses, the DMX/RDM statuses, Network status, inner system temperature, the main phase voltages and the frequency.

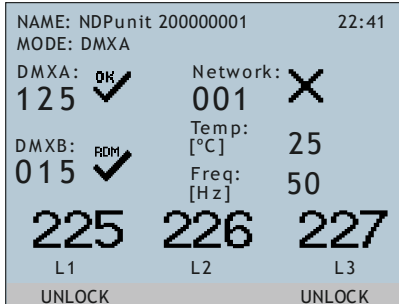

DMX/Network status:



DMX or Network is OK



RDM communication is OK



DMX or Network is not connected



DMX signal is inverted or one of the signals is missing or is short circuited.

Temperature status:

25

Number shows the temperature of dimmer in °C

25

Inverted number indicates WARNING. System temperature is higher or lower than the value selected by user, in this case 25 degrees of Celsius.

Phase Voltages:

225

The voltage of each phase in Volts is displayed at the bottom of LCD.

225

Inverted number indicates WARNING. Voltage of particular phase is higher or lower than the value selected by user.

Frequency status:

50

Number shows the line frequency in Hz.

50

Inverted number indicates WARNING. Line frequency is higher or lower than the value selected by user.

Rotating the Encoder shows the following quick view screens:

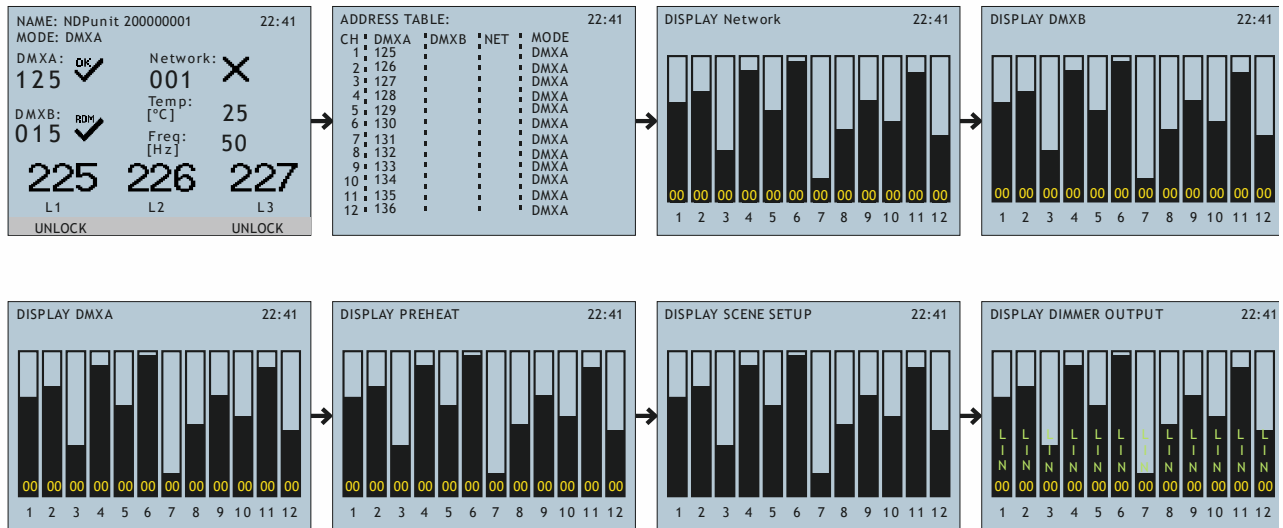

Address table:

Address table shows the mode of operation and address patch for every channel. First column shows the number of channel. Second and third columns are the user patched addresses for DMXA and DMXB inputs, respectively. Next column displays the user patched address for Network input. The last one indicates the mode of operation for every channel. Possible modes of operation are DMXA, DMXB, Network, HTP, LTP and Manual.

Display Network:

Shows actual values on channels received over the Network.

Display DMXB:

Shows actual values on channels received over the DMXB input.

Display DMXA:

Shows actual values on channels received over the DMXA input.

Display Preheat:

Shows preheat values assigned by user.

Display Scene Setup:

Indicates the output values of dimmer scene generator. Active [latch]:[flash] shows the active latch scene and flash scenes.

Display Dimmer Output:

Indicates real output values on channels after dimmer signal processing.

Menu navigation:

To enter the menu, unlock the device by pressing both buttons at the same time and press the Encoder. Rotate the Encoder to highlight the desired option and press the Encoder to enter:

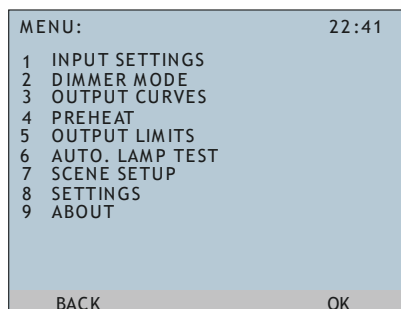

1. INPUT SETTINGS
 - 1.1 DMXA start address
 - 1.2 DMXB start address
 - 1.3 Network start address
 - 1.4 DMXA patch
 - 1.5 DMXB patch
 - 1.6 Network patch
2. DIMMER MODE
 - 2.1 DMXA
 - 2.2 DMXB
 - 2.3 Network
 - 2.4 MANUAL
 - 2.5 PATCH
 - 2.6 HTP DMXA+DMXB
 - 2.7 LTP DMXA+DMXB
 - 2.8 HTP DMXA+Network
 - 2.9 LTP DMXA+Network
 - 2.10 HTP DMXB+Network
 - 2.11 LTP DMXB+Network
 - 2.12 HTP DMXA+DMXB+Network
 - 2.13 LTP DMXA+DMXB+Network
3. OUTPUT CURVES
 - 3.1 Curves for all channels
 - 3.2 Curve per channel
 - 3.3 Setup of user curves
4. PREHEAT
5. OUTPUT LIMITS
6. AUTO. LAMP TEST
7. SCENE SETUP
 - 7.1 Modes & Delay
 - 7.2 Scene 01-16
8. SETTINGS
 - 8.1 LCD BackLight
 - 8.2 Time/Date
 - 8.3 Network
 - 8.4 Art-Net
 - 8.5 sACN
 - 8.6 Passwords
 - 8.7 Warnings
 - 8.8 Memory
 - 8.9 USB Device
 - 8.10 Soft Reset
 - 8.11 Hard Reset
 - 8.12 Software update
9. ABOUT

1. INPUT SETTINGS

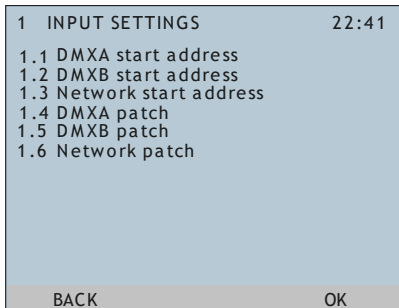

Rotate the Encoder to select the desired input setting and press the Encoder or OK to confirm. To start the address setting, select submenu 1.1 for DMXA, 1.2 for DMXB, 1.3 for Network. A new screen will be shown.

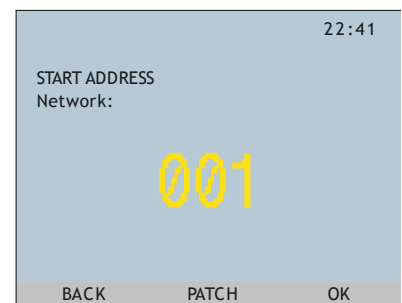
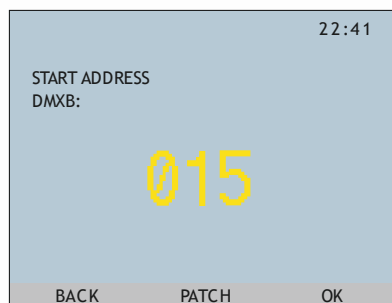
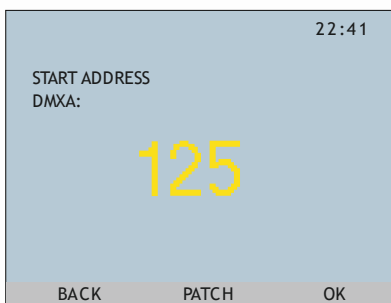

Rotate the Encoder until you reach the desired value of the start address and press OK. Remaining addresses will be incremented by one. To set different addresses for every channel, use the submenu 1.4 for DMXA, 1.5 for DMXB, 1.6 for Network or press the Encoder in the start address menu [PATCH].

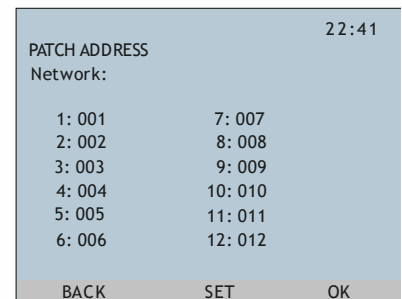
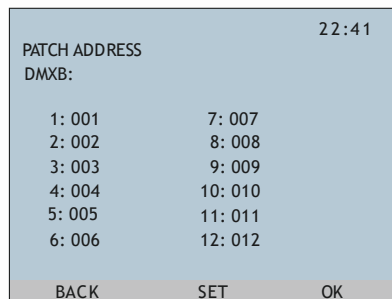
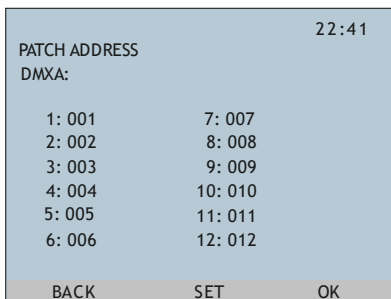

Press the Encoder for patch settings.

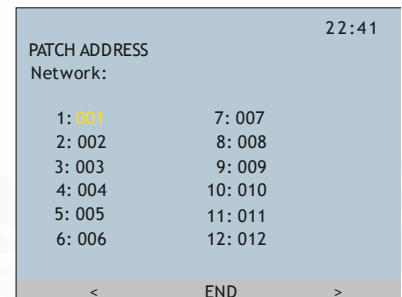
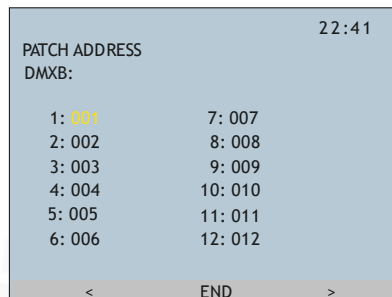
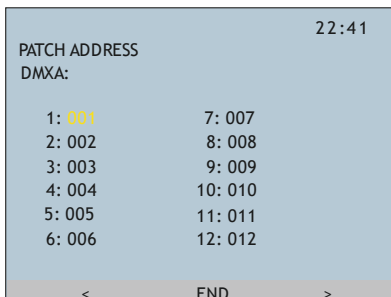

Select the desired channel using left and right button. Rotate the Encoder to set the desired value of appropriate channel. Press the Encoder to quit the editing mode or navigate to the position before channel 1 or position after channel 12 and press OK to save changes. To discard changes, press BACK.

2. DIMMER MODE

2	DIMMER MODE	22:41
2.1	DMXA	
2.2	DMXB	
2.3	Network	
2.4	MANUAL	
2.5	PATCH	
2.6	HTP DMXA+DMXB	
2.7	LTP DMXA+DMXB	
2.8	HTP DMXA+Network	
2.9	LTP DMXA+Network	
2.10	HTP DMXB+Network	
2.11	LTP DMXB+Network	
2.12	HTP DMXA+DMXB+Network	
2.13	LTP DMXA+DMXB+Network	
BACK		OK

2	DIMMER MODE	22:41
2.2	DMXB	
2.3	Network	
2.4	MANUAL	
2.5	PATCH	
2.6	HTP DMXA+DMXB	
2.7	LTP DMXA+DMXB	
2.8	HTP DMXA+Network	
2.9	LTP DMXA+Network	
2.10	HTP DMXB+Network	
2.11	LTP DMXB+Network	
2.12	HTP DMXA+DMXB+Network	
2.13	LTP DMXA+DMXB+Network	
BACK		OK

To set the whole dimmer to the DMXA input, select 2.1 by rotation of the Encoder and confirm by pressing OK. For DMXB select 2.2, for Network select 2.3, for the manual mode select 2.4. Mode on each channel can be set individually using the submenu 2.5 PATCH.

ADDRESS TABLE:				22:41
CH	DMXA	DMXB	NET	MODE
1	125	:	:	DMXA
2	126	:	:	DMXA
3	127	:	:	DMXA
4	128	:	:	DMXA
5	129	:	:	DMXA
6	130	:	:	DMXA
7	131	:	:	DMXA
8	132	:	:	DMXA
9	133	:	:	DMXA
10	134	:	:	DMXA
11	135	:	:	DMXA
12	136	:	:	DMXA
BACK		SET	OK	

ADDRESS TABLE:				22:41
CH	DMXA	DMXB	NET	MODE
1	125	:	:	DMXA
2	126	:	:	DMXA
3	127	:	:	DMXA
4	128	:	:	DMXA
5	129	:	:	DMXA
6	130	:	:	DMXA
7	131	:	:	DMXA
8	132	:	:	DMXA
9	133	:	:	DMXA
10	134	:	:	DMXA
11	135	:	:	DMXA
12	136	:	:	DMXA
<		END	>	

Enter the editing mode by pressing the Encoder. Navigate to proper item by pressing left and right button and select mode for channel by the Encoder. Address can be changed if selected modes are DMXA, DMXB, Network, HTP or LTP. The output value can be changed if the manual mode is selected. Press the Encoder to quit the editing mode. Press OK to store settings or BACK to discard settings.

To set the dimmer in HTP or LTP mode, select one of the 2.6 – 2.13 items and press OK.

- 2.6 HTP DMXA+DMXB
- 2.7 LTP DMXA+DMXB
- 2.8 HTP DMXA+Network
- 2.9 LTP DMXA+Network
- 2.10 HTP DMXB+Network
- 2.11 LTP DMXB+Network
- 2.12 HTP DMXA+DMXB+Network
- 2.13 LTP DMXA+DMXB+Network

3. OUTPUT CURVES

To set the output curves, enter the OUTPUT CURVES Menu.

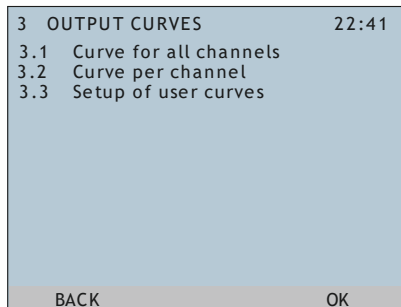

To set one common output curve for the whole dimmer, select submenu 3.1. There are four options for output curves to choose from: LINEAR, S-CURVE, LOGARITHMIC AND SWITCH. Moreover, user can choose one of three curves (USER 1 – USER 3) defined by user in section 3.3.

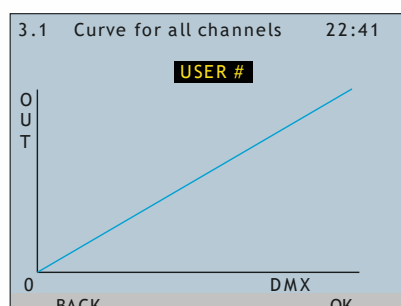
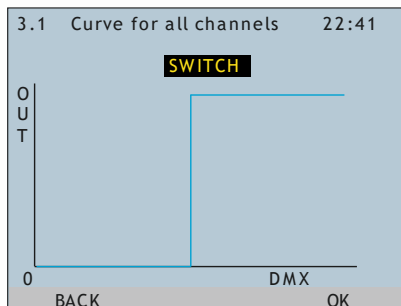
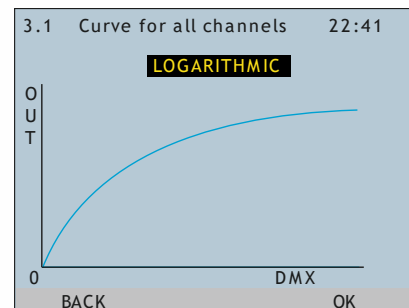
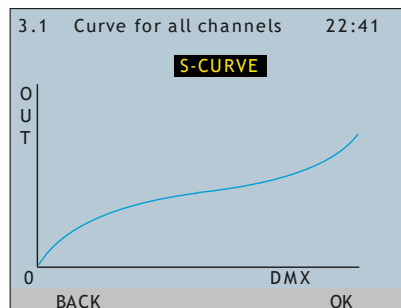
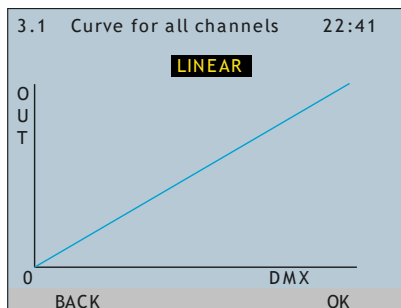

Rotate the Encoder to choose one of the options and press OK to store the curve. To discard changes, press BACK.

To set the curve for each channel individually, choose submenu 3.2.

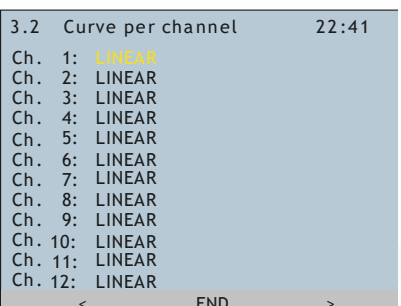
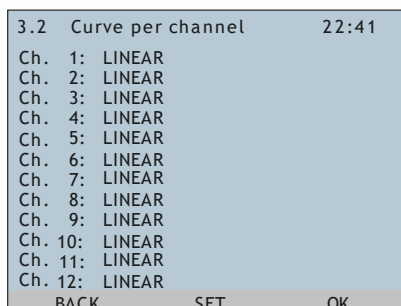

To enter the editing mode, press the Encoder (SET). Use left and right button to select the channel and rotate the Encoder to choose a curve for selected channel. Press Encoder to quit the editing

mode or navigate to the position before channel 1 or position after channel 12 and press OK to save changes or BACK to discard changes.

Apart from LINEAR, S-CURVE, LOGARITHMIC AND SWITCH curves, user can create his/her own curve. Up to three curves can be defined in section 3.3 Setup of user curves.

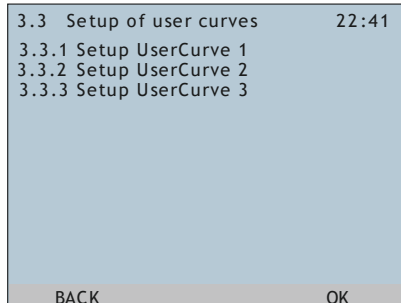

In the submenu, navigate onto one of three UserCurves using the Encoder and confirm by pressing the Encoder or OK button.

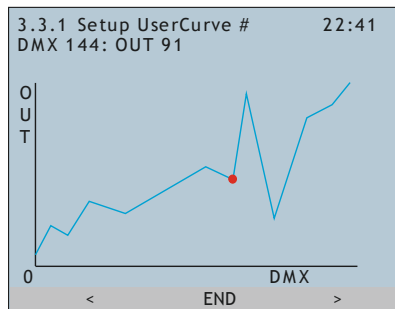
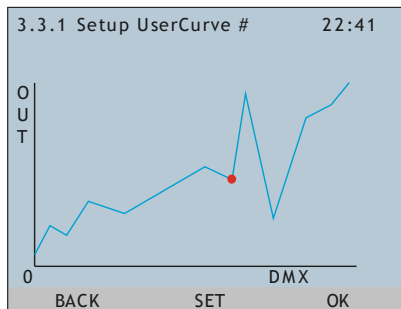

To amend the curve, press the Encoder [SET]. Use left and right button to select the DMX address [selects every 16 – 0,16,32,48,... starting at 0 and ending at 255] and rotate the Encoder to select the output level [from 0 to 255] for selected DMX address. A red dot symbolizes the position of cursor. Press Encoder to quit the editing mode or navigate to the position before DMX address 0 or position after DMX address 255 and press OK to save changes or BACK to discard changes.

4. PREHEAT

To set preheat, enter the PREHEAT Menu.

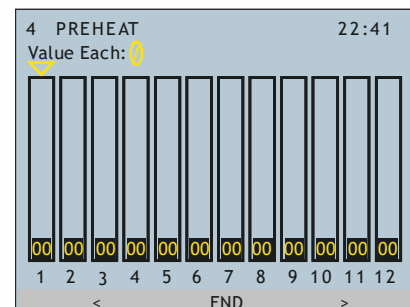
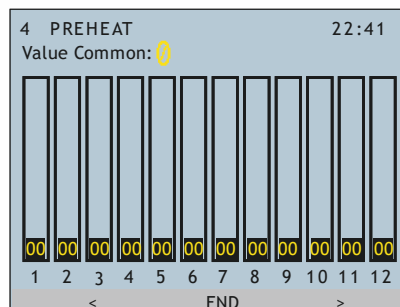
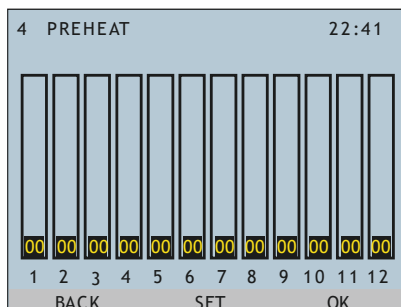

To enter the editing mode, press the Encoder [SET]. Use left and right button to select the channel. First option is common preheat value setting and is followed by individual channel setting. When the option is selected, rotate the Encoder to set value for preheat. Press the Encoder to quit the editing mode or navigate to the position before Common Value or position after Value on channel 12 and press OK to save changes or BACK to discard changes.

5. OUTPUT LIMITS

To set the output limits, enter the OUTPUT LIMITS Menu.

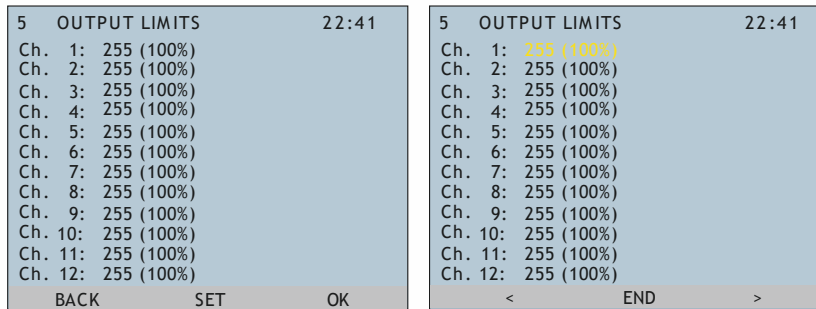

To enter the editing mode, press the Encoder [SET]. Use left and right button to select the channel. When the option is selected, rotate the Encoder to set the value of output limit. First number shows the DMX address, second is the percentage. Press the Encoder to quit the editing mode or navigate to the position before channel 1 or position after channel 12 and press OK to save changes or BACK to discard changes.

6. AUTOMATIC LAMP TEST

Enter menu item number 6 to start automatic lamp test.

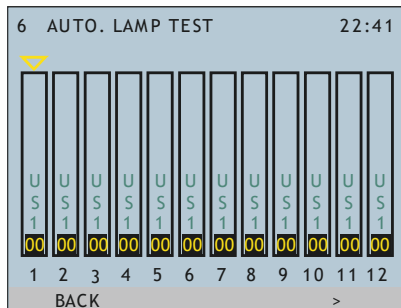

Each channel will be tested by increasing/decreasing the output value individually one by one. Press the right button to move on the next channel. Press BACK to quit the automatic lamp test.

7. SCENE SETUP

Select menu item 7 to enter the dimmer scene generator setup. Scene generator is controlled via first two channels of the DMXB input. First channel selects the scene number. Second channel activates the selected scene by receiving value higher than 127 from the DMXB input. To set up the generator, select submenu 7.1 Modes & Delay. Press the Encoder or OK to confirm.

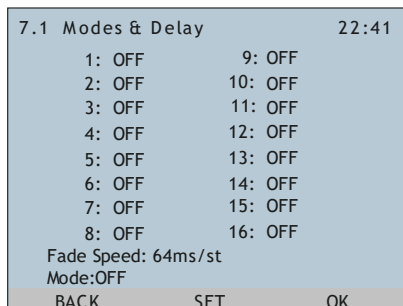
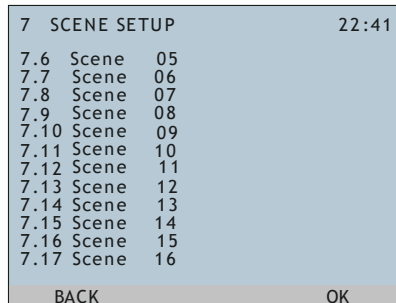
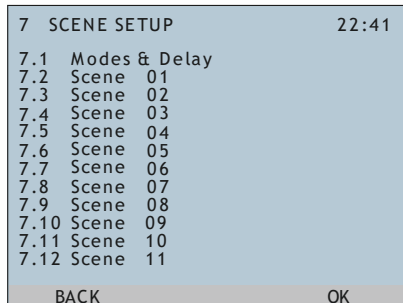

To enter the editing mode, press the Encoder (SET). To change the scene mode, navigate to desired scene using right and left button and change the mode by rotating the Encoder. Possible modes are OFF, LATCH and FLASH. To change the fade speed, select Fade Speed. Fade speed is the time required to change step (ms/step). Scene generator modes are OFF, LTP/dimmer, LTP/channel, HTP/channel. Quit this submenu by pressing the Encoder (END). Press OK to save changes or BACK to discard changes.

To create or edit scene 01 – 16, select submenu 6.2 – 6.17 and press OK.

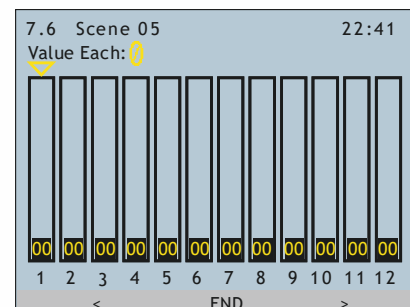
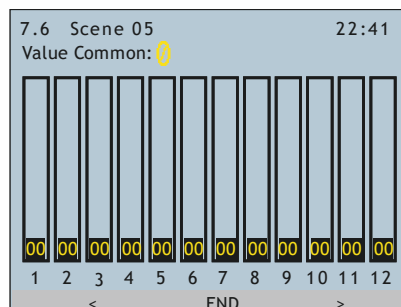
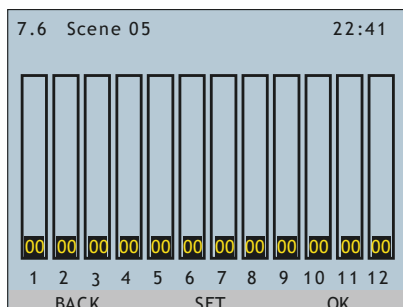

Enter the editing mode by pressing the Encoder (SET). Use right and left button to select the channel and rotate the Encoder to change the value of output. Quit the editing mode by pressing the Encoder (END). To save changes press OK or discard changes by pressing BACK.

8. SETTINGS

Access to various dimmer settings is available in menu section 8. SETTINGS.

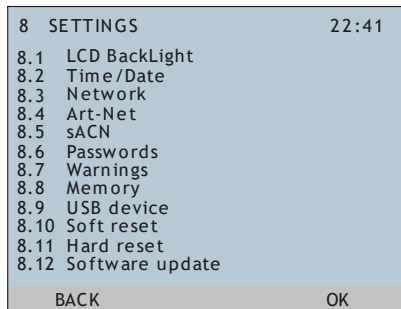

Rotate the Encoder to reach the desired subsection and press the Encoder or OK to enter. Every subsection is described in detail below.

8.1 LCD BackLight

To enter the editing mode, press the Encoder [SET]. Rotate the Encoder to set desired backlight intensity value of LCD. Press the right button and rotate the Encoder to set the off time [in minutes]. Press Encoder to quit the editing mode [END]. Press OK to save the changes or press BACK to discard changes.

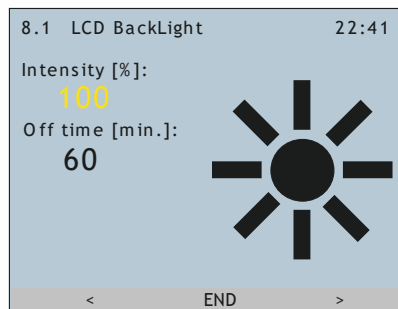
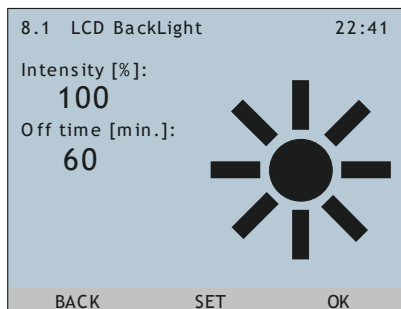

8.2 Time/Date

Press the Encoder [SET] to enter the editing mode. Use left and right button to navigate to value to be changed. Set proper value by rolling the Encoder. Press the Encoder to quit the editing mode. Press OK to save changes or BACK to discard changes.

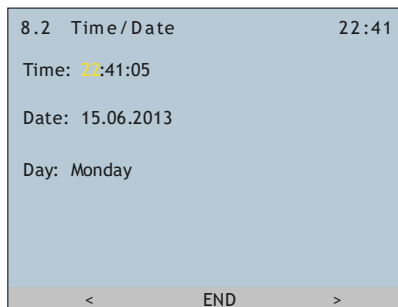

8.3 Network

Enter the editing mode by pressing the Encoder [SET]. Use left and right button to navigate to the value to be changed. Enter correct IP address. To set the network mask, insert the CIDR value after the slash. Press the Encoder to quit the editing mode. Press OK to store value or press BACK to discard changes.

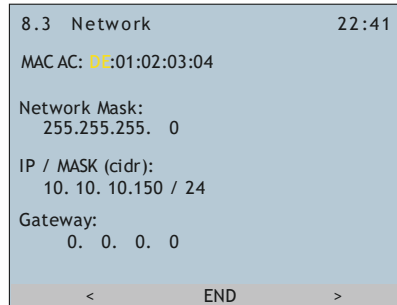
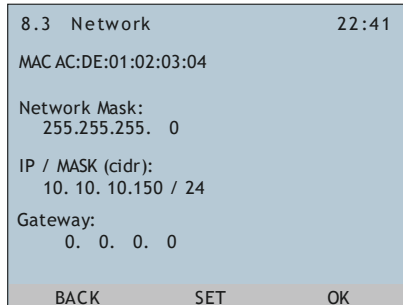

8.4 Art-Net

Press the Encoder to enter the editing mode. Select value to be changed. Navigate Port, Subnet, Short Name or Long Name items by pressing left and right buttons. Change values by rotating the Encoder. Press Encoder to exit the editing mode. Press OK to save the setup or BACK to discard changes.

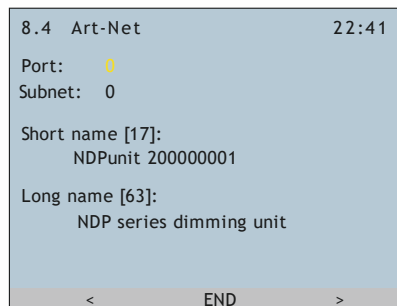
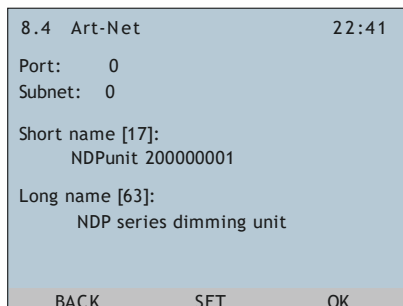

8.5 sACN

Rotate the Encoder to select the value of the sACN universe. Any number from 1 to 63999 including can be selected. Press the Encoder to reset the value. Press OK to save the setup or BACK to discard changes.

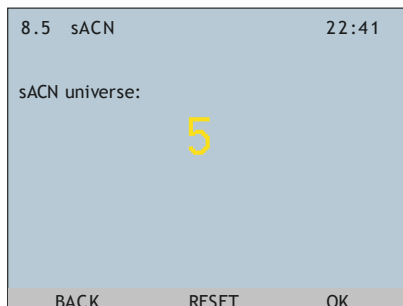

8.6 Passwords

Section Passwords includes three submenus for passwords in order of their level of priority; Keyboard being least prior, Admin the most.

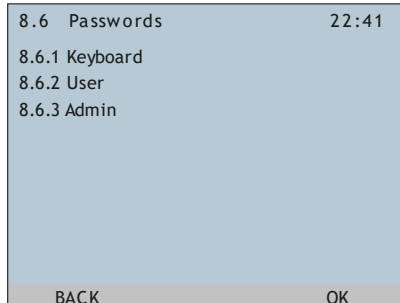

Rotate the Encoder to select the type of password to be set and confirm by a press of Encoder or OK button. One of the following screens will appear:

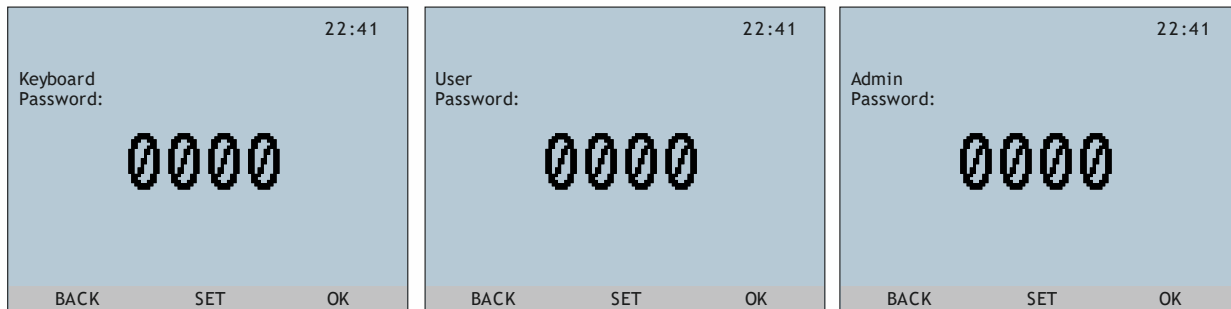

Here you have to enter the correct password. Rotate the Encoder to switch between types of password to be entered. You can only switch to password with higher priority. For Keyboard password setting, all kinds of passwords can be entered, for User password setting User and Admin passwords can be entered, for Admin password setting Admin password has to be entered.

By default, Keyboard password is 1111, User 1234 and Admin 0000.

Choose the type of password to be entered and press the Encoder (SET) to enter the password.

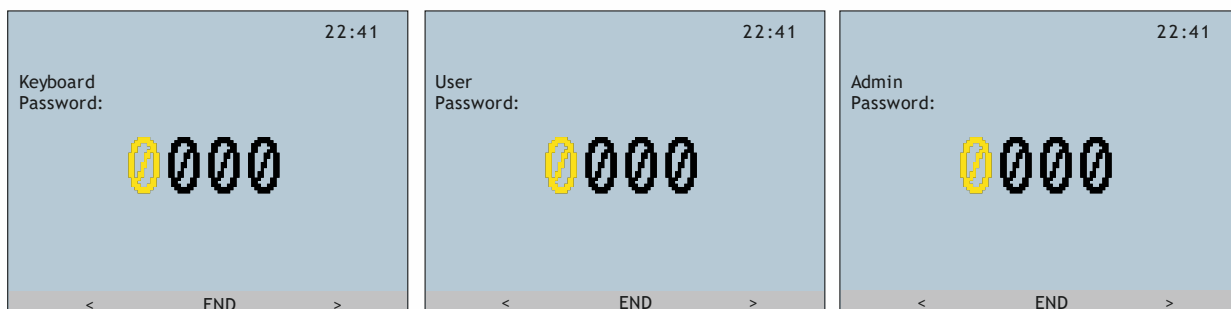

Rotate the Encoder to choose a proper value [from 0 to 9 including]. Use left and right button to navigate to next/previous digit. After the password has been entered, navigate to the position before first digit or after last digit or press the Encoder (END). Press OK button to confirm. If the password is correct, an "OK" sign is displayed and the Password setting screen appears. An "ERR" sign means incorrect password; please try again.

8.6.1 Keyboard password is the first level of NDP security. If Keyboard password option is enabled, correct password must be entered to unlock the initial menu of the dimmer. The Password setting screen shows currently set password, Enable and Auto lock options.

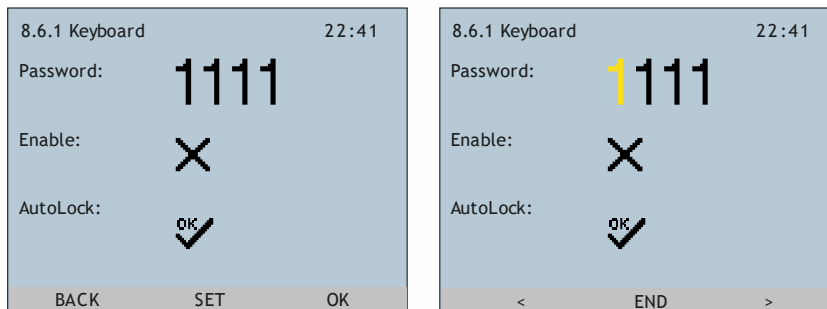

Enter the editing mode by pressing the Encoder [SET]. Use left and right button to navigate to the value to be changed. Password consists of 4 integers. To activate the Keyboard password, select Enable and rotate the Encoder to change the cross icon to OK icon. Now the Keyboard password is active. Auto-lock function provides automatic lock option in case of inactivity for more than 3 seconds. To enable this function, navigate to AutoLock and enable it by rolling the Encoder. To quit the editing mode, press the Encoder [END]. To save changes press OK, to discard changes press BACK.

By default, Keyboard password is 1111, disabled and Auto lock disabled.

8.6.2 User password is the second level of NDP security. If User password option is enabled, correct User or Admin password must be entered to access the DMXA, DMXB and Network patch addresses and to set the output limits, Time/Date, Network, Art-Net, sACN, warnings and resets. The Password setting screen shows currently set password and Enable option.

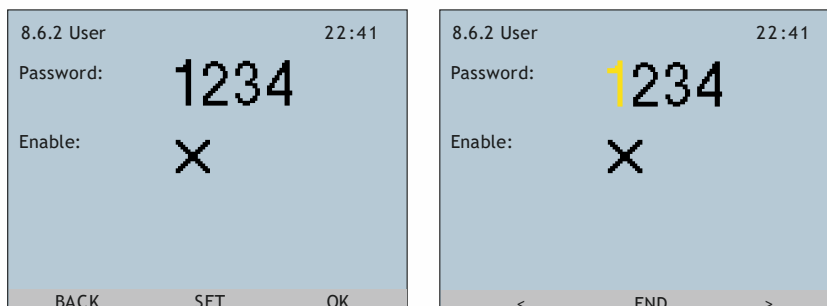

Enter the editing mode by pressing the Encoder [SET]. Use left and right button to navigate to the value to be changed. Password consists of 4 integers. To activate the User password, select Enable and rotate the Encoder to change the cross icon to OK icon. Now the User password is active. To quit the editing mode, press the Encoder [END]. To save changes press OK, to discard changes press BACK.

By default, User password is 1234 and disabled.

8.6.3 Admin password is the highest level of NDP security. If Admin password option is enabled, correct Admin password must be entered to set Time/Date and warnings and to do the hard reset. The Password setting screen shows currently set password and Enable option.

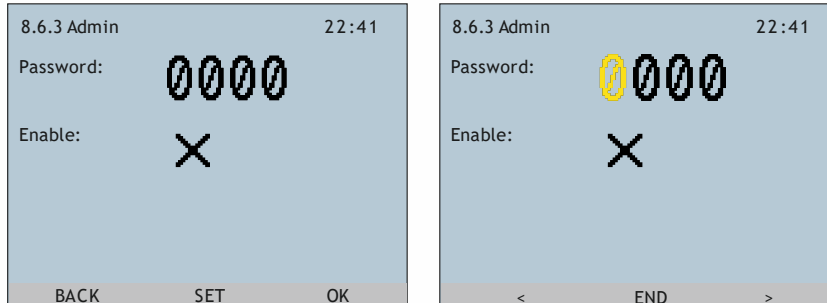

Enter the editing mode by pressing the Encoder [SET]. Use left and right button to navigate to the value to be changed. Password consists of 4 integers. To activate the Admin password, select Enable and rotate the Encoder to change the cross icon to OK icon. Now the Admin password is active. To quit the editing mode, press the Encoder [END]. To save changes press OK, to discard changes press BACK.

By default, Admin password is 0000 and enabled.

8.7 Warnings

This setup consists of limit values for NDP dimmer function. In this setup, minimal and maximal phase voltages, operating temperature and frequency can be changed. Hard limits set by factory are wider than user selectable values. User can set narrow range of operating limits to meet his/her requirements.

Enter the editing mode by pressing the Encoder [SET]. Navigate to the value to be changed using left and right buttons and set it to the required value by rolling the Encoder. Quit the editing mode by pressing the Encoder [END]. To store changes, press OK; to discard, press BACK.

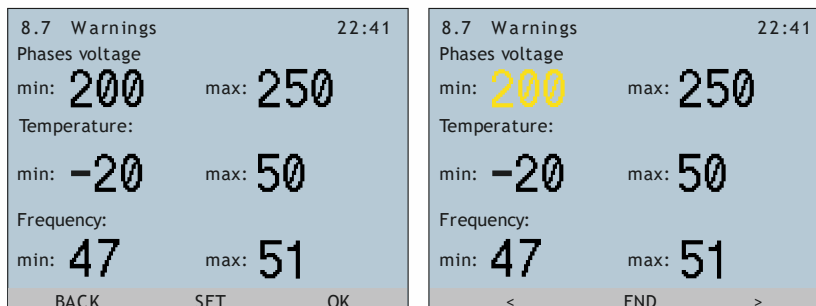

8.8 Memory /available only when USB Device is connected/

This feature gives a possibility to store the current setting of dimmer and to load it later. To store the current settings of dimmer, rotate the Encoder to the Memory place you wish to save settings to and press SAVE. Free memory place is indicated with [free] string. If memory place is used, the name of unit, date and time are showed under the Memory place. To reload configuration, rotate the Encoder to the memory place you wish to reload and press LOAD. Now the settings of dimmer are reloaded. To erase memory rotate the Encoder to the Memory place you wish to erase and press ERASE.

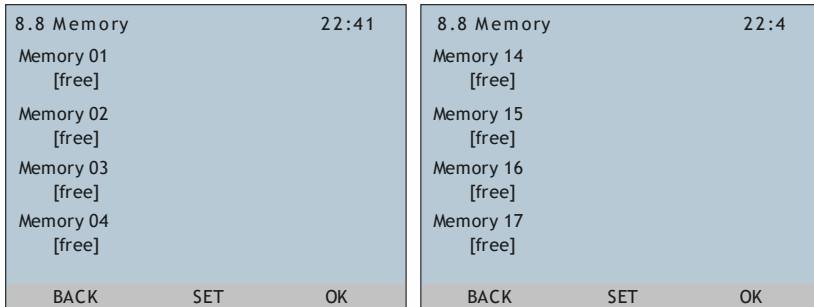

8.9 USB Device /available only when USB Device is connected/

The USB Device section shows the information about files stored on USB Mass storage device connected to front USB port. The information includes the total number of files, their names and the type of selected file (only bitmap is supported).

Use the Encoder to scroll to the desired file and press OK.

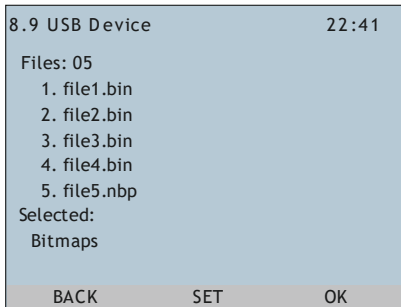

8.10 Soft reset

This option allows setting NDP to the user standard. Soft reset will set factory defaults for:

1. DMX Start Addresses and Patch
2. Dimmer mode
3. Preheat & Manual values
4. Art-Net universes and names
5. sACN universe



Press the right button to proceed or the left button to return.

8.11 Hard reset

Hard reset sets the whole NDP to factory defaults. Hard reset menu includes items in the Soft reset one, but is extended with other items:

1. DMX Start Addresses and Patch
2. Dimmer mode
3. Preheat & Manual values
4. Art-Net universes and names
5. sACN universe
6. Unlock user & keyboard
7. Network address
8. Backlight
9. Keyboard/User passwords
10. Curves
11. Warnings

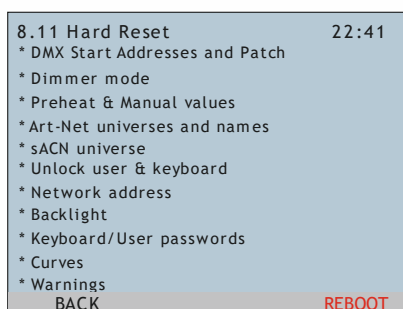

Press the right button to proceed or the left button to return.

8.12 Software update

In this submenu, user can update software of the NDP unit. Ask the manufacturer for a boot loader and further information on how to proceed.

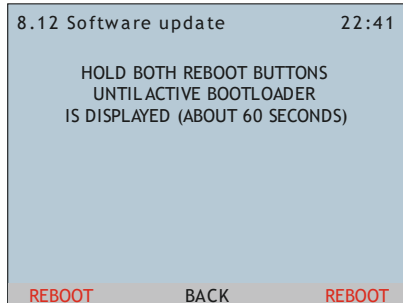

Press both buttons at the same time and hold them until BOOTLOADER active screen is shown to start the update. Press the Encoder [BACK] to return to the Settings menu.

9. ABOUT

This screen provides overall information about current NDP dimmer pack. It shows:

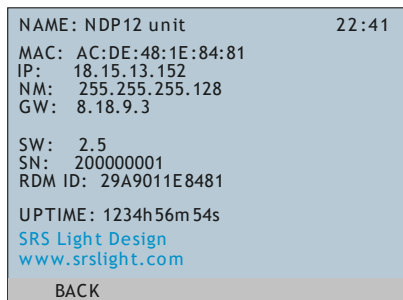

1. NAME of the unit
2. MAC Address
3. IP Address
4. Network Mask [NM]
5. Gateway [GW]
6. Software version [SW]
7. Serial Number [SN]
8. RDM ID
9. Overall UP Time

Press the left button [BACK] to return to the main menu.

Technical data

Dimming capacity

NDPx1210	12x10A	12x2.3kW
NDPx1213	12x13A	12x3kW
NDPx1216	12x16A	12x3.7kW
NDPx6025	6x25A	6x5.7kW
NDPx6032	6x32A	6x7.3kW

Housing:

Steel housing with gray powder coating
482.5 x 132 x 420 mm

Weight:

NDP12xx: 29 kg
NDP60xx: 25 kg

Interference suppression:

In-line precision filters: 400us

Protection:

Short circuit protection by MCB
Optional 1P+N short circuit protection
Double thermal protection

Ventilation:

100% duty cycle
Temperature-controlled fan
Automatic shutdown at critical temperature

Other:

All safety features are displayed on the display
Soft start
Controlling of special functions via display, three keys and Encoder
Circuit breakers on the front panel
Easy change of power output connectors

Display Functions:

Voltage of all 3 phases
Single channel values
Inner temperature
Load status check
DMX signal status
Art-Net status

Digital menu functions:

Preheat per channel
Dimmer curve per channel
Single channel patch
Variable channel set
DMX processing with fast output response
Hold function for output in case of the DMX data failure

Power Cable:

H07RNF cable 5 x 4/6/10 mm²

Inputs and Outputs:

Pin out for the XLR connectors:

Pin 1	Data CMN (not connected to earth)
Pin 2	Data -
Pin 3	Data +
Pin 4, 5	Not connected

The DMX Input and Outputs are connected in ratio 1:1

Pin out for the NDP12xx Terminal board for direct cable connection:

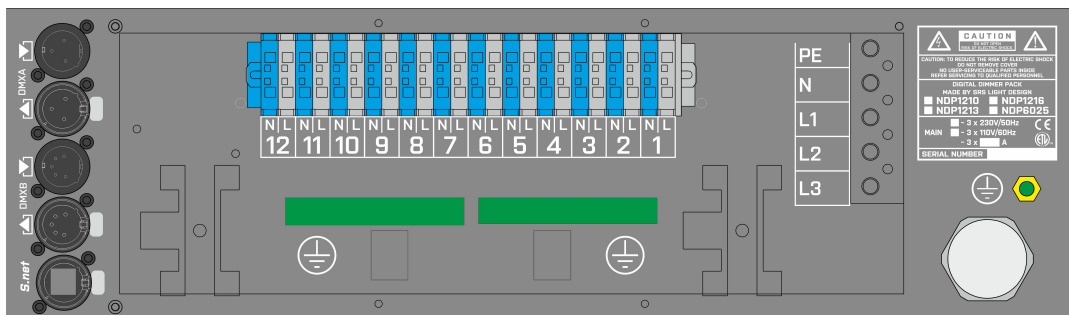

Pin out for the NDP60xx Terminal board for direct cable connection:

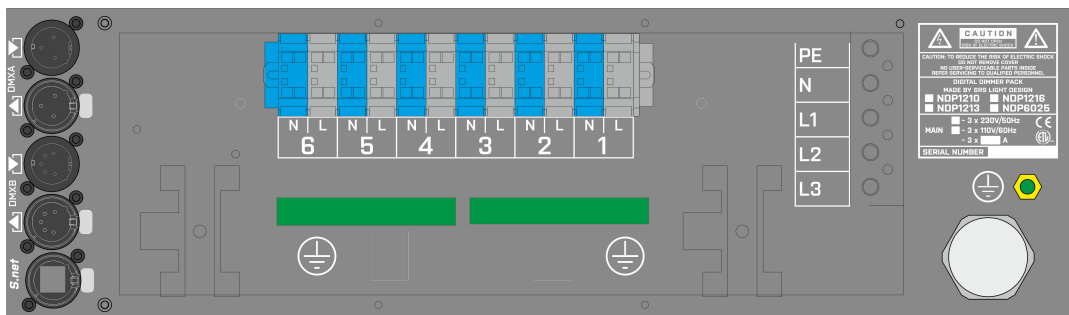

Pin out for the SOCAPEX connectors:

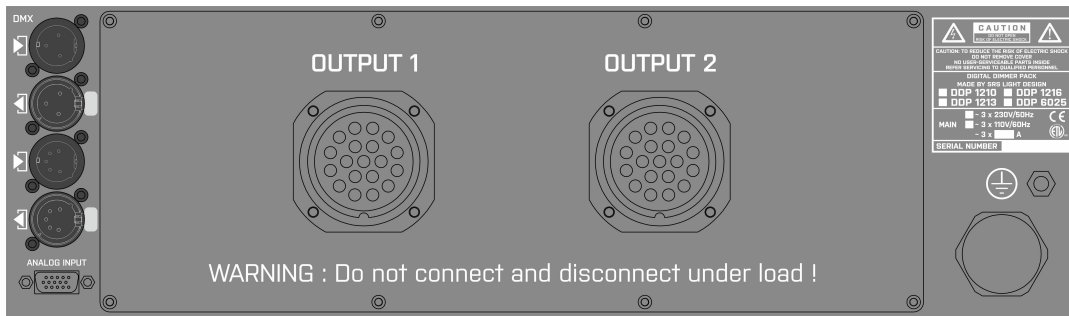

Output 1:

Pin 1,3,5,7,9,11 Phase 1,2,3,4,5,6
 Pin 2,4,6,8,10,12 Neutral
 Pins 13-19 Earth

Output 2:

Pin 1,3,5,7,9,11 Phase 7,8,9,10,11,12
 Pin 2,4,6,8,10,12 Neutral
 Pins 13-19 Earth

Pin out for the Harting/Ilme 24 connectors:

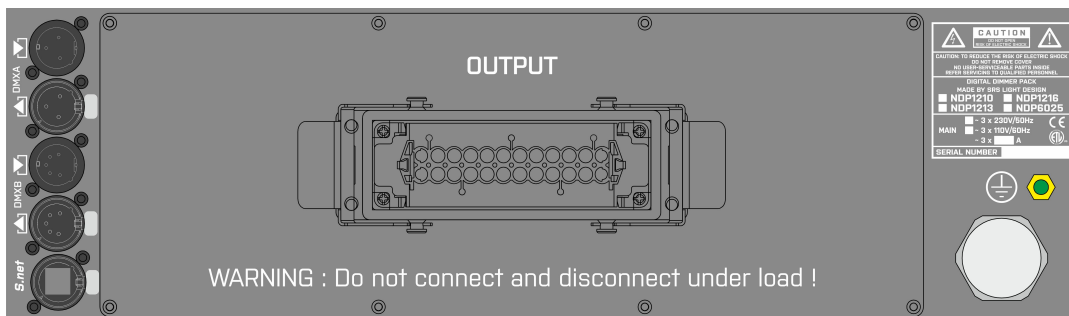

Pins 1-12 Phases 1-12
 Pins 13-24 Neutral

Pin out for the Harting/Ilme 16 connectors /Type A – phase + neutral, top + bottom/

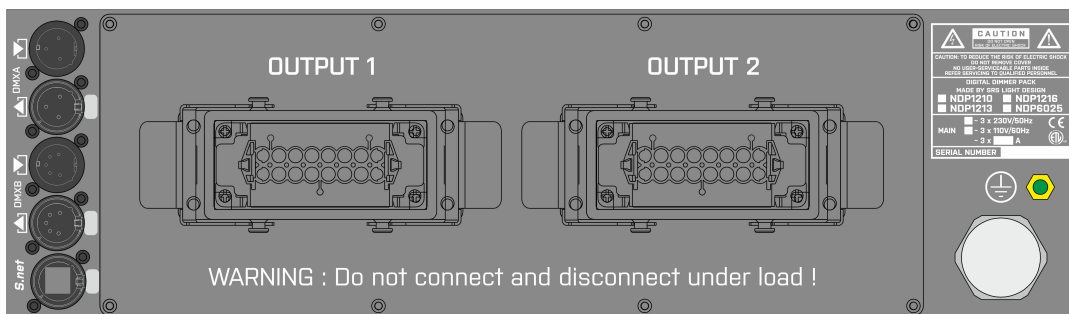

Pins 1-6 Phases 1-6/7-12
 Pins 9-14 Neutral

Pin out for the Harting/Ilme 16 connectors /Type B – phase + neutral inline/

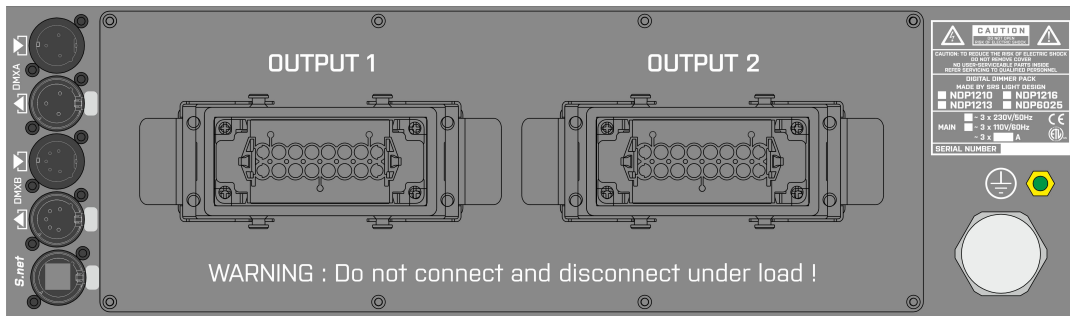

Pin 1,3,5,7,9,11 Phase 1-6/7-12
 Pin 2,4,6,8,10,12 Neutral

Pin out for the 4x Harting/Ilme 16 connectors /type of wiring on request/

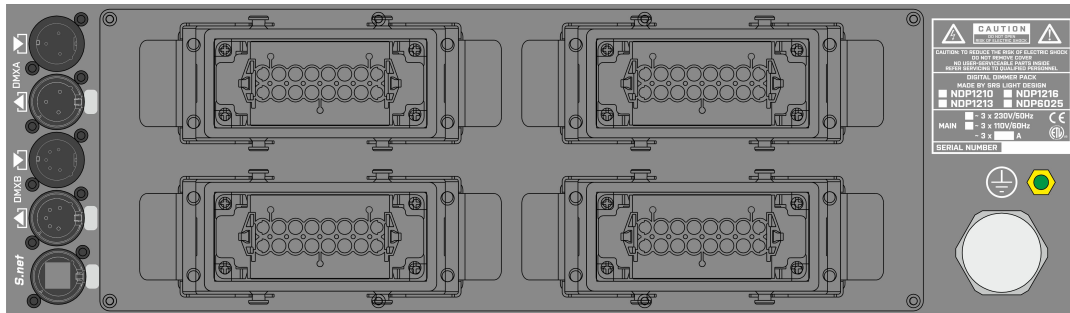

Pin out for the Ilme 6 connectors:

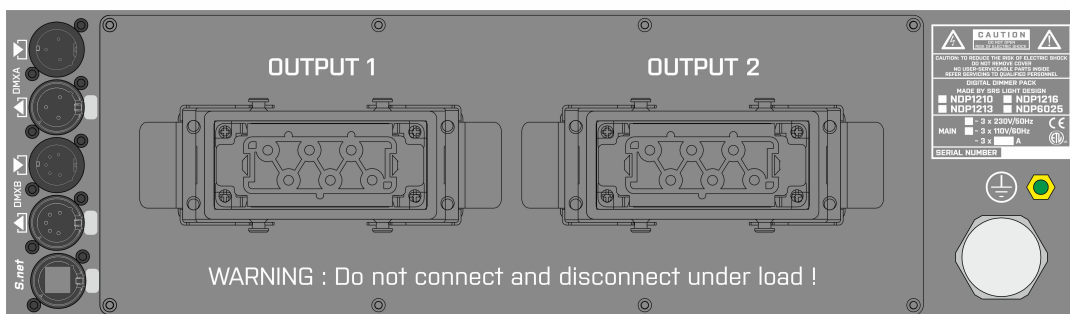

Output 1:
 Pin 1,2,3 Phase 1,2,3
 Pin 2,4,6 Neutral

Output 2:
 Pin 1,2,3 Phase 4,5,6
 Pin 2,4,6 Neutral

Pin out for the 12x Socket /French, Schuko, UK, Danish,.../

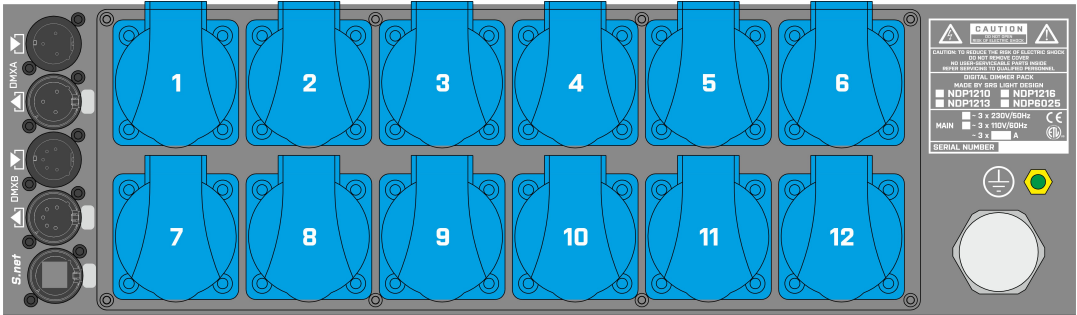

Pin out for the 12x CEE16/3p type 17 socket

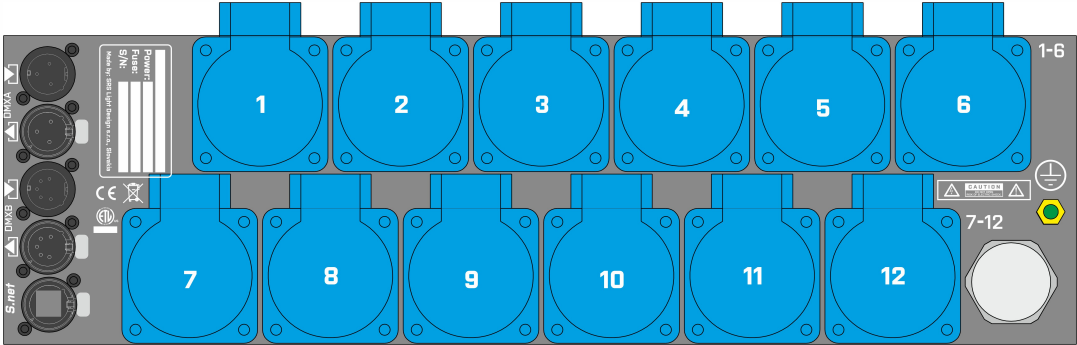

Pin out for the 6x CEE32/3p socket

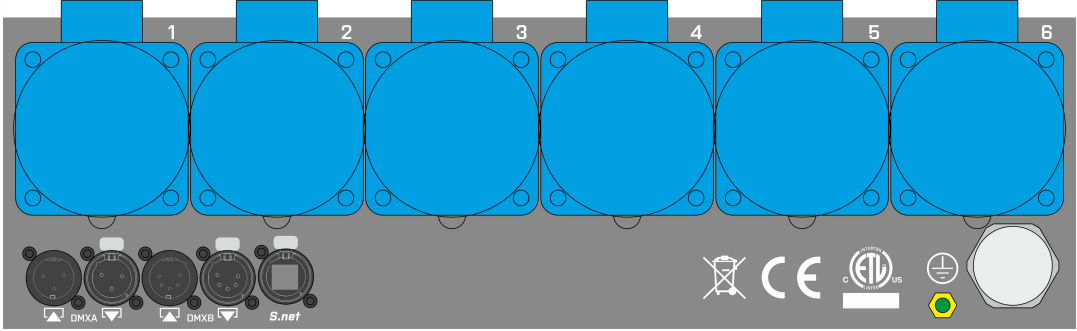



Declaration of conformity

We hereby declare that the equipment described below conforms to its design, type and version introduced by us to the fundamental safety and health requirements of the EU Guidelines Machines.

Manufacturer:
SRS Group
Rybnicna 38/B
83107 Bratislava
Slovakia

Declares that the product:

Name of product: Network Dimming Pack
Type/version: **NDP12xx, NDP60xx, NDPN60xx, NDPN12xx**

Correspond to the following specifications:

EN 60-950-1:2003
EN 55103-1:2000
EN 55103-2:2000
EN 60-598-2-17 1989 including amendments 1/2
EN 60-598-1 1992 including amendment 1

CE marking directive 93/68 EEC
Low voltage directive (2006/95/EG)
EMC directive (2004/108/EWG)

Bratislava, 29 December 2013

Robert Sloboda

Copyright 2017 SRS Group, s.r.o. | Specifications subject to change without notice.
Document: NDP12XX_en_manual_M156 | Version 3.0 | Actual as of: 3 February 2020



SRS Group s.r.o.

Rybnicna 38/B | 831 07 Bratislava | Slovakia

Phone: +421 2 32 661 800

Email: sales@srs-group.com | www.srs-group.com

